

Article number: 12735000040100

Description: KLEE-coil 735 000 040.100
M4 Steel

Measures

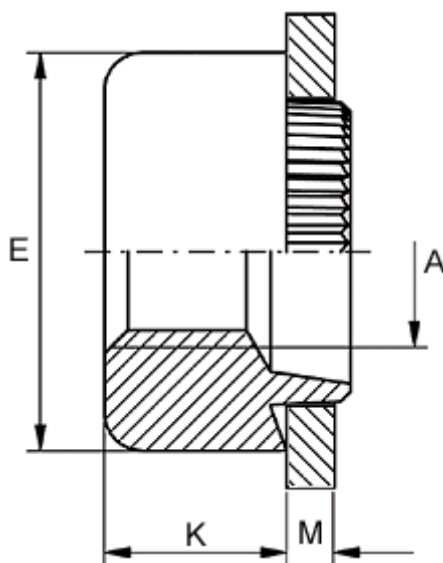

Female thread A	= M4
Height K	= 3.0
Outer diameter E	= 7.0
Plate thickness	= 4.1 to 4.3
Recommended bore diameter +0.05	= 6.0